

Data sheet | Item number: 855-3001/200-001

Split-core current transformer; Primary rated current: 200 A; Secondary rated current: 1 A; Rated power: 0.2 VA; Accuracy class: 1; Cable length: 3 m

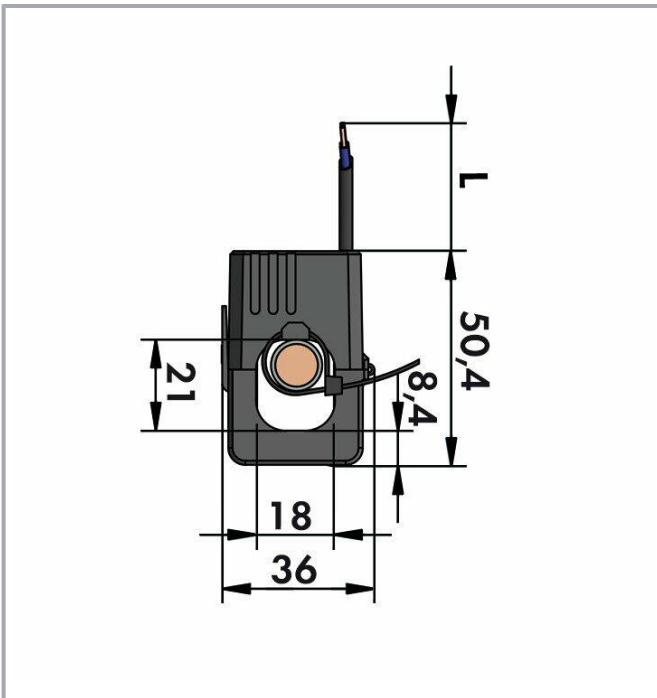

[www.wago.com/855-3001/200-001](http://www.wago.com/855-3001/200-001)

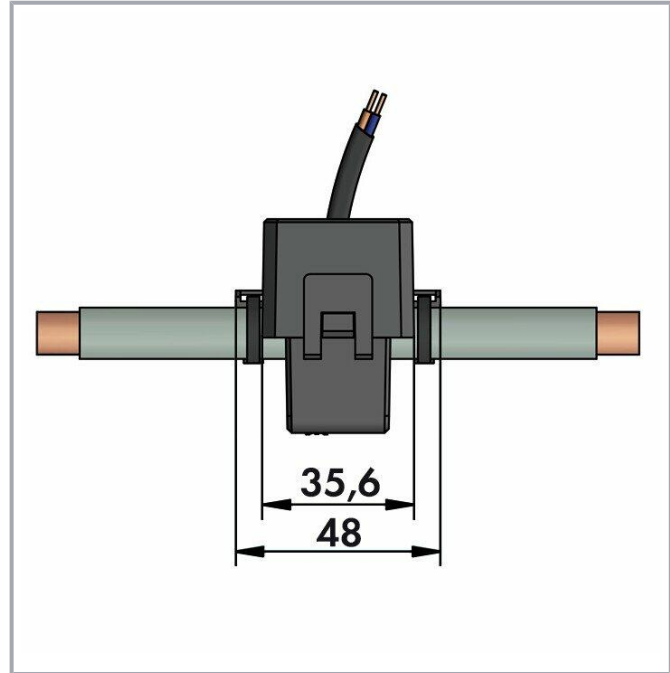

Subject to changes. Please also observe the further product documentation!

WAGO GmbH & Co. KG  
Hansastr. 27  
32423 Minden  
Phone: +49571 887-0 | Fax: +49571 887-169  
Email: [info.de@wago.com](mailto:info.de@wago.com) | Web: [www.wago.com](http://www.wago.com)

Do you have any questions about our products?  
We are always happy to take your call at +49 (571) 887-44222.



## Item description

### Short description:

WAGO's compact split-core current transformers are ideal for retrofitting existing systems. They are perfect for applications in which the current path must not be disrupted. The transformer's accuracy permits extremely precise current measurements. The split-core current transformers are capable of supplying the specified rated power at the end of the secondary cable. All transformers are supplied with color-coded cables. Two UV-resistant cable ties are also included for secure and easy mounting.

### Features:

- Current ratios from 200 A (primary side) and 1 A (secondary side)
- No primary cable interruption
- Ideal for use in very confined spaces
- Rapid mounting
- For use around insulated conductors (18 mm Ø)
- Compact and hinged
- Color-coded connection cable (3 m)

## Data

### Technical data

#### Input Current Transformers

Primary rated current	200 A
Rated continuous thermal current $I_{cth}$	100 %
Rated short-time thermal current $I_{th}$	$60 \times I_N / 1 \text{ s}$
Rated surge current $I_{dyn}$	$2.5 \times I_{th}$
Rated frequency	50 ... 60 Hz

#### Output (current transformer)

Secondary rated current	1 A
Rated power $S_r$	0.2 VA

#### Measurement Error

Accuracy class	1
----------------	---

Subject to changes. Please also observe the further product documentation!

## Safety and protection

Highest voltage for equipment $U_m$	AC 720 V <sub>rms</sub>
Protection type	IP20

## Test voltage

Test voltage	AC 6 kV; 50 Hz; 1 min
--------------	-----------------------

## Connection data

Feedthrough for measurement conductor	Ø 18 mm
Cable type	2 x 0.5 mm <sup>2</sup> ; fine-stranded
Color code	Brown = S1; blue = S2

## Physical data

Cable length	3 m
--------------	-----

## Mechanical Data

Mounting type	Split-core current transformer (suspended)
---------------	--

## Material Data

Flammability class per UL94	V2
Weight	10 g

## Environmental requirements

Ambient temperature (operation)	-10 ... +55 °C
Ambient temperature (storage)	-20 ... +70 °C
Relative humidity	5 ... 85 % (without condensation)
Operating altitude (max.)	2000 m

## Standards and specifications

Conformity marking	CE
Standards/specifications	EN 61869-1 EN 61869-2

Subject to changes. Please also observe the further product documentation!

## Commercial data

eCl@ss 10.0	27-21-09-02
eCl@ss 9.0	27-21-09-02
ETIM 8.0	EC002048
ETIM 7.0	EC002048
PU (SPU)	1 pcs
Packaging type	box
Country of origin	NL
GTIN	4050821880677
Customs tariff number	85043180888

## Environmental Product Compliance

RoHS Compliance Status	Compliant, No Exemption
------------------------	-------------------------



## Approvals / Certificates

### General approvals

Logo	Approval	Additional Approval Text	Certificate name
	EAC Brjansker Zertifizierungsstelle	TP TC 004/2011, TP TC 020/2011	EAC RU C-DE.AM02. B.00111 /19

## Optional accessories

### Mounting

Current transformer terminal block		
	<b>Item no.: 2007-8874</b> Compact terminal block; for current and voltage transformers; 6,00 mm <sup>2</sup> ; multicoloured	<a href="http://www.wago.com/2007-8874">www.wago.com/2007-8874</a>
	<b>Item no.: 2007-8877</b> Compact terminal block; for current transformer circuit; 6,00 mm <sup>2</sup> ; multicoloured	<a href="http://www.wago.com/2007-8877">www.wago.com/2007-8877</a>
	<b>Item no.: 2007-8875</b> Compact terminal block; for current transformer circuit; 6,00 mm <sup>2</sup> ; multicoloured	<a href="http://www.wago.com/2007-8875">www.wago.com/2007-8875</a>

Subject to changes. Please also observe the further product documentation!



**Item no.: 2007-8876**

Compact terminal block; for 3-phase current transformer circuit; 6,00 mm<sup>2</sup>; multicoloured

[www.wago.com/2007-8876](http://www.wago.com/2007-8876)



**Item no.: 2007-8873**

Compact terminal block; for current and voltage transformers; 6,00 mm<sup>2</sup>; multicoloured

[www.wago.com/2007-8873](http://www.wago.com/2007-8873)

## Signal conditioner

### Power measurement module



**Item no.: 2857-570/024-001**

3-Phase Power Measurement Module; 3x277/480 V/1 A; Modbus RTU; Digital output; Configuration via software; Supply voltage: 24 VDC

[www.wago.com/2857-570/024-001](http://www.wago.com/2857-570/024-001)

### Current signal conditioner



**Item no.: 857-550**

Current signal conditioner; Current input signal; Current and voltage output signal; Digital output; Configuration via software; Supply voltage: 24 VDC; 6 mm module width; 2,50 mm<sup>2</sup>

[www.wago.com/857-550](http://www.wago.com/857-550)



**Item no.: 857-551**

Current signal conditioner; Current input signal; Current and voltage output signal; Digital output; Configuration via software; Supply voltage: 24 VDC; 6 mm module width

[www.wago.com/857-551](http://www.wago.com/857-551)

## Downloads

### Documentation

#### Bid Text

855-3001/200-001 X81 - Datei	2019 Feb 19	xml 5.3 kB	Download
855-3001/200-001 doc - Datei	2015 Feb 5	doc 31.2 kB	Download

#### Instruction Leaflet

Kabelumbau-Stromwandler	V 1.1.0 2020 Jan 15	pdf 832.5 kB	Download
-------------------------	------------------------	-----------------	----------

#### Additional Information

Disposal and Recycling Electrical and electronic equipment, Batteries, Packaging	V 1.1.0 2022 Aug 18	pdf 2.2 MB	Download
---	------------------------	---------------	----------

Subject to changes. Please also observe the further product documentation!

## Engineering-Software

### Configuration and Commissioning Software

WAGO Interface Configuration Software G2 FULL	1.00.10.01	exe	Download
The full setup, in addition to the WAGO Interface Configuration Software G2, includes the installation for the Microsoft .NET Framework.	2022 Jan 20	114.9 MB	

## Environmental Product Compliance

### Compliance Search

Environmental Product Compliance 855-3001/200-001	URL	Download
Split-core current transformer; Primary rated current: 200 A; Secondary rated current: 1 A; Rated power: 0.2 VA; Accuracy class: 1; Cable length: 3 m		

## Installation Notes

### Installation



Simple termination!



Quick and easy mounting!



Subject to changes. Please also observe the further product documentation!